

TECHNICAL INFORMATION

CITIZEN QUARTZ

Cal. No. B020

Cal. No. B030



CITIZEN

CITIZEN IS A REGISTERED TRADEMARK OF CITIZEN WATCH CO., JAPAN.

Contents

§1. OUTLINE1

§2. SPECIFICATIONS1

§3. HANDLING OF WATCH2

 A. Solar Power Watch.....2

 B. Setting the Time2

 C. Functions of the Sollar Powered Watch3

 D. Time Required for Recharge4

§4. NOTES ON RECHARGE5

§5. REPLACING THE SECONDARY BATTERY5

§6. PRECAUTIONS FOR DISASSEMBLY AND ASSEMBLY6

§7. DISASSEMBLY AND ASSEMBLY OF MOVEMENT (Cal. B020) [B023]..7

§8. DISASSEMBLY AND ASSEMBLY OF MOVEMENT (Cal. B030) [B033]..8

§9. TROUBLESHOOTING AND ADJUSTMENT9

NOTE:
All Instructions for B020 apply to B023

All Instructions for B030 apply to B033

§1. OUTLINE

This watch is a ladie's solar power watch which has a solar cell on its dial that converts the light energy into electrical energy to drive its mechanism.

§2. SPECIFICATIONS

Caliber NO.		B020 / B023	B030 / B033
Type		Analog solar power watch	
Movement size (mm)		ø16.0 x 14.9 x 12.5 x 2.5t	ø16.0 x 14.9 x 12.5 x 2.8t
Accuracy (At normal temperature)		±15 sec/month (5°C~35°C/41°F~95°F)	
IC		1 unit of C/MOS-LSI	
Operating temperature		-10°C~+60°C (14°F~140°F)	
Converter		Bipolar step motor	
Time adjustment		No adjustment terminal for use in market	
Measurement gate		10 sec.	
Movement of hand		Movement by 20 sec.	Movement by 1 sec.
Indicating function		Hour, Minute	Hour, Minute, Second
Additional functions		Insufficient charge warning function	
		Time setting warning function	
		Overcharging prevention function	
Continuous Operating time	From full recharge to stop	Approx. 5 months	Approx. 2 months
	From insufficient charge warning display to stop	Approx. 5 days	Approx. 1 day
Secondary battery	Part NO.	295-46	
	Remarks	Secondary battery block (With welded lead plate)	

§3. HANDLING OF WATCH

A. Solar Power Watch

This watch is powered not by an ordinary battery, but by converting light energy into electrical energy.

A secondary battery is used in this watch to store electrical energy. **This secondary battery is a clean energy battery which doesn't use any toxic substances such as mercury. Once fully charged, the two-hand model (Cal. B020) will continue to run for about 5 months, while the three-hand model (Cal. B030) will continue to run for about 2 months without further charging.**

[Explain the following items to the user for comfortable use of this watch.]

<Good use of solar-powered watch>

- Since the energy source of this watch is light, expose it to light sufficiently to charge the battery in it.
- Once this watch stops, it takes some time to charge the battery enough to start itself. Accordingly, try to charge the battery every day.
- * If the watch has stopped, expose it to light of 3000Lux (at a distance of about 20cm from a fluorescent lamp) for about 5 hours if it is CAL. B020 and about 1 hour if it is CAL. B030 to start it again.
- The battery of this watch is never overcharged by exposing it to light.
- If the user wears long-sleeved clothes usually, the watch is covered and its battery may not be charged sufficiently.
- The watch should be put on a well lit place as long as possible for its normal operation while it is not worn.

B. Setting the Time

[Two-Hand Model (Cal. B020)]

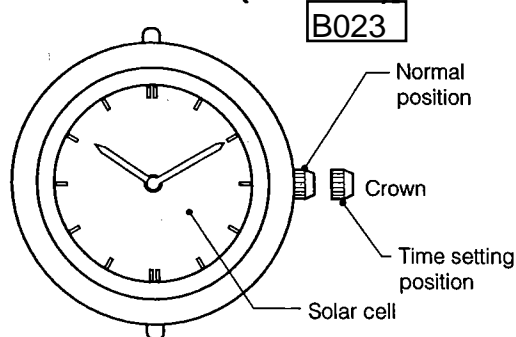

[Three-Hand Model (Cal. B030)]

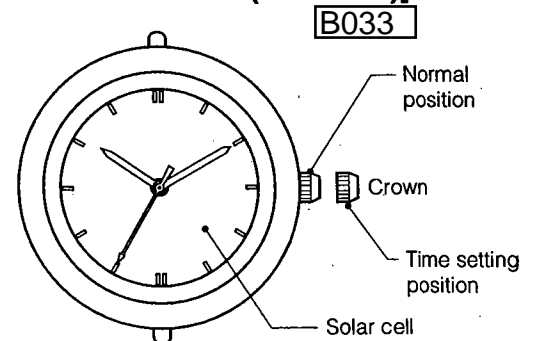

■ Setting the time

1. Pull the crown out to the time setting position (the second hand will stop when the crown is pulled out in the case of the three-hand model).
2. Turn the crown to set the time.
3. After setting the time, firmly push the crown back in to the normal position.

C. Functions of Solar Powered Watch

If the charge becomes insufficient, a warning function will be activated that causes the display to change as shown below.

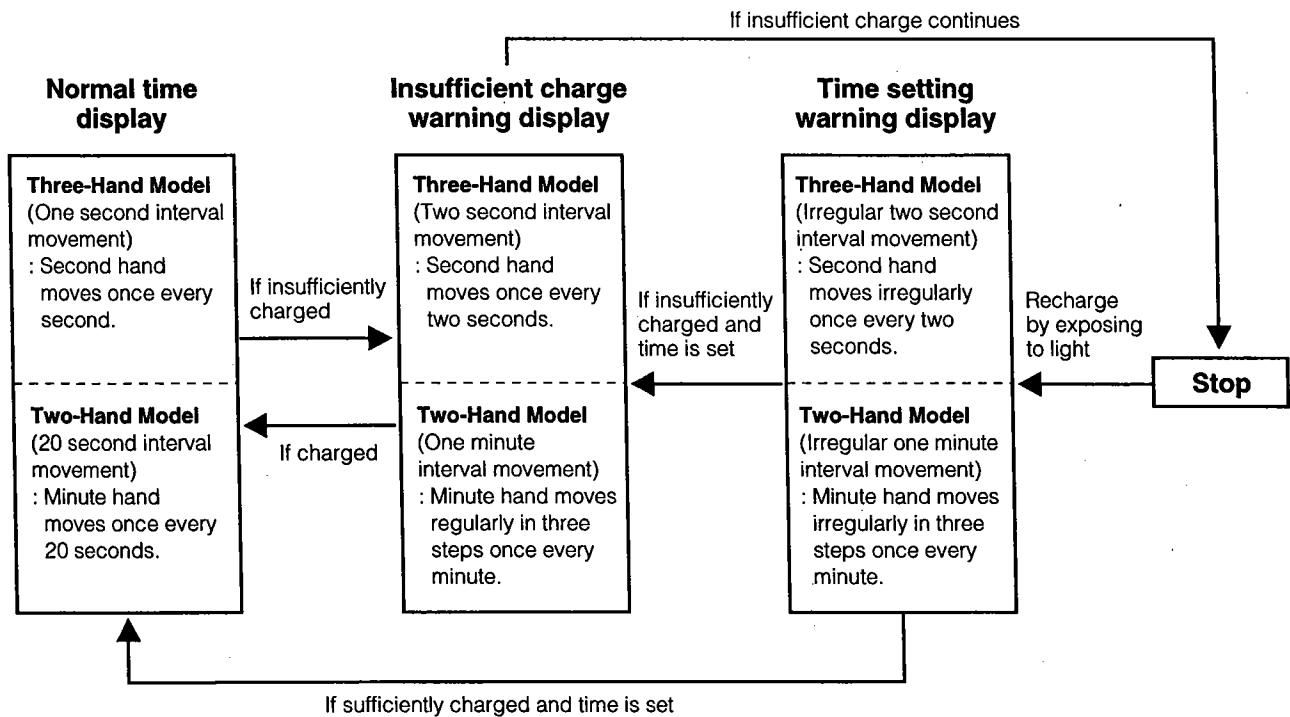

■ Insufficient Charge Warning Function

In the case of the two-hand model, the minute hand moves by one minute interval movement, and in the case of the three-hand model, the second hand moves by two second interval movement to indicate insufficient charging.

Although the watch keeps the correct time when this happens, the watch will stop after about 5 days in the case of the two-hand model or after about 1 day in the case of the three-hand model, after the start of one minute interval movement or two second interval movement.

Recharge the watch by exposing to light. The watch will then begin to run normally again.

[One minute interval movement]

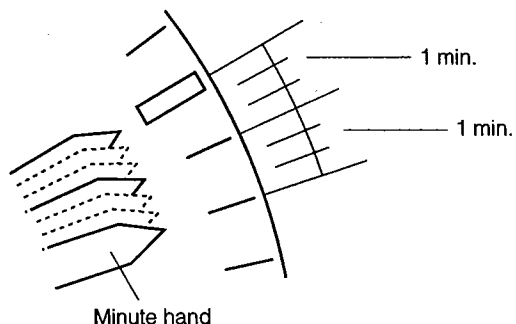

[Two second interval movement]

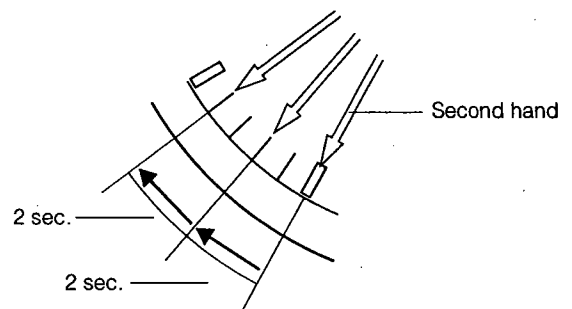

■ Time Setting Warning Function

Although the watch hands will begin to move when the watch is charged after stopping, since the time is incorrect, the minute hand will move by irregular one minute interval movement in the case of the two-hand model, or the second hand will move by irregular two second interval movement in the case of the three-hand model to indicate that the time is incorrect. When this happens, fully recharge the watch and reset the time. The watch will continue to run by the irregular interval movement until the time is reset even if fully charged.

[Irregular one minute interval movement]

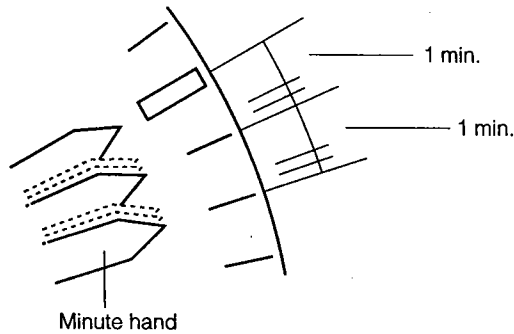

[Irregular two second interval movement]

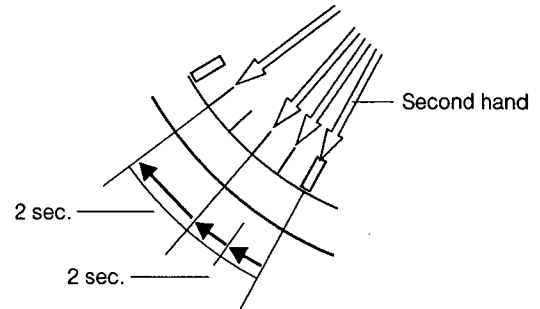

■ Overcharge Prevention Function

You can recharge without worry

Once the secondary battery is fully recharged, the overcharging prevention feature comes into operation and prevents over-recharging.

D. Time Required for Recharge

Time required for recharge may vary according to the Caliber No. design (color of the dial, etc.) and operating environment. The following table will serve you as rough reference.

"The recharging time is the time when the watch is continuously exposed to radiation."

(For Cal. B020)

Illuminance (lux)	Environment	Time required		
		Two-hand model (Cal. B020) B023		
		From the stop state to the 20 seconds movement	One day usage	Empty to full
500	Inside an ordinary office	52 hours	1 hour 10 minutes	360 hours
1000	60-70cm (24-28in.) under a fluorescent light (30W)	26 hours	40 minutes	180 hours
3000	20cm (8in.) under a fluorescent light (30W)	8 hours 30 minutes	12 minutes	57 hours
10000	Exterior, cloudy	2 hours 30 minutes	4 minutes	20 hours
100000	Exterior, summer, sunny	35 minutes	2 minutes	7 hours

(For Cal. B030)

Illuminance (lux)	Environment	Time required		
		Three-hand model (Cal. B030) B033		
		From the stop state to the one second movement	One day usage	Empty to full
500	Inside an ordinary office	12 hours	2 hours	160 hours
1000	60-70cm (24-28in.) under a fluorescent light (30W)	5 hours 30 minutes	1 hour	75 hours
3000	20cm (8in.) under a fluorescent light (30W)	2 hours	20 minutes	24 hours
10000	Exterior, cloudy	30 minutes	7 minutes	9 hours
100000	Exterior, summer, sunny	8 minutes	3 minutes	3 hours 30 minutes

Full recharging timeThe time for fully recharge from stopped.
(Empty to full)

One day usageThe time required for the watch to run for one day with one second interval movement (Cal. B030) or 20 seconds interval movement (Cal. B020).

* The recharging time is the time when the watch is continuously exposed to radiation.

§4. NOTES ON RECHARGE

- Avoid recharging at high temperatures (over about 60°C/140°F), otherwise the watch will be damaged during recharging.

(eg) Charging the watch near a light source that easily becomes hot, such as an incandescent lamp or a halogen lamp.

Charging in a place that easily becomes hot, such as a dashboard.

When you charge the watch by an incandescent lamp, take a distance about 50cm (20in.) from the light source to prevent extremely high temperature.

§5. REPLACING THE SECONDARY BATTERY

This watch uses the secondary battery, which does not have to be periodically replaced due to repeated charging and discharging, unlike ordinary batteries.

 **Caution**

Never use a battery other than the secondary battery used in this watch.

The watch structure is so designed that a different kind of battery other than the specified cannot be used to operate it. In case a different kind of battery such as a silver battery is used by some chance, there is a danger that the watch will be overcharged to burst, causing damage to the watch and even to the human body.

§6. PRECAUTIONS FOR DISASSEMBLY AND ASSEMBLY

Solar cell block

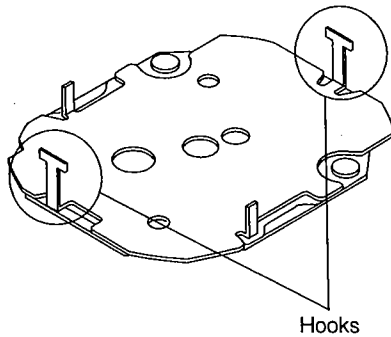

<Solar cell block>

The solar cell block consists of the solar cell (Cal. B020: Film solar cell, Cal. B030: Glass solar cell) and a metallic panel which are glued to each other. Do not remove the solar cell forcibly from the metallic panel. (The solar cell is fixed to the movement with two hooks at the 12-o'clock position and 6-o'clock position.)

If the top of the solar cell is damaged, the battery is not charged sufficiently. Accordingly, handle it with extreme care.

Lever of the yoke

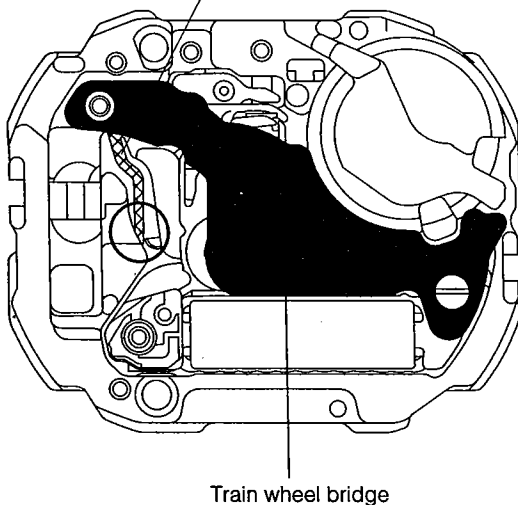

<Precautions for setting the train wheel>

Take care not to forget install the lever of the yoke. After tightening the screws of the train wheel bridge, put the lever of the yoke under the spacer for the setting stem securely (See the figure).

§7. DISASSEMBLY AND ASSEMBLY OF MOVEMENT (Cal. B020)

Disassembly procedure: ① → ②②
 Assembly procedure: ②② → ①

● Lubrication mark

- Ⓐ : A-Lube oil
- Ⓥ : V-Lube oil
- ⓕ : F-Lube oil
- ⓄⓄ : CH-1 oil

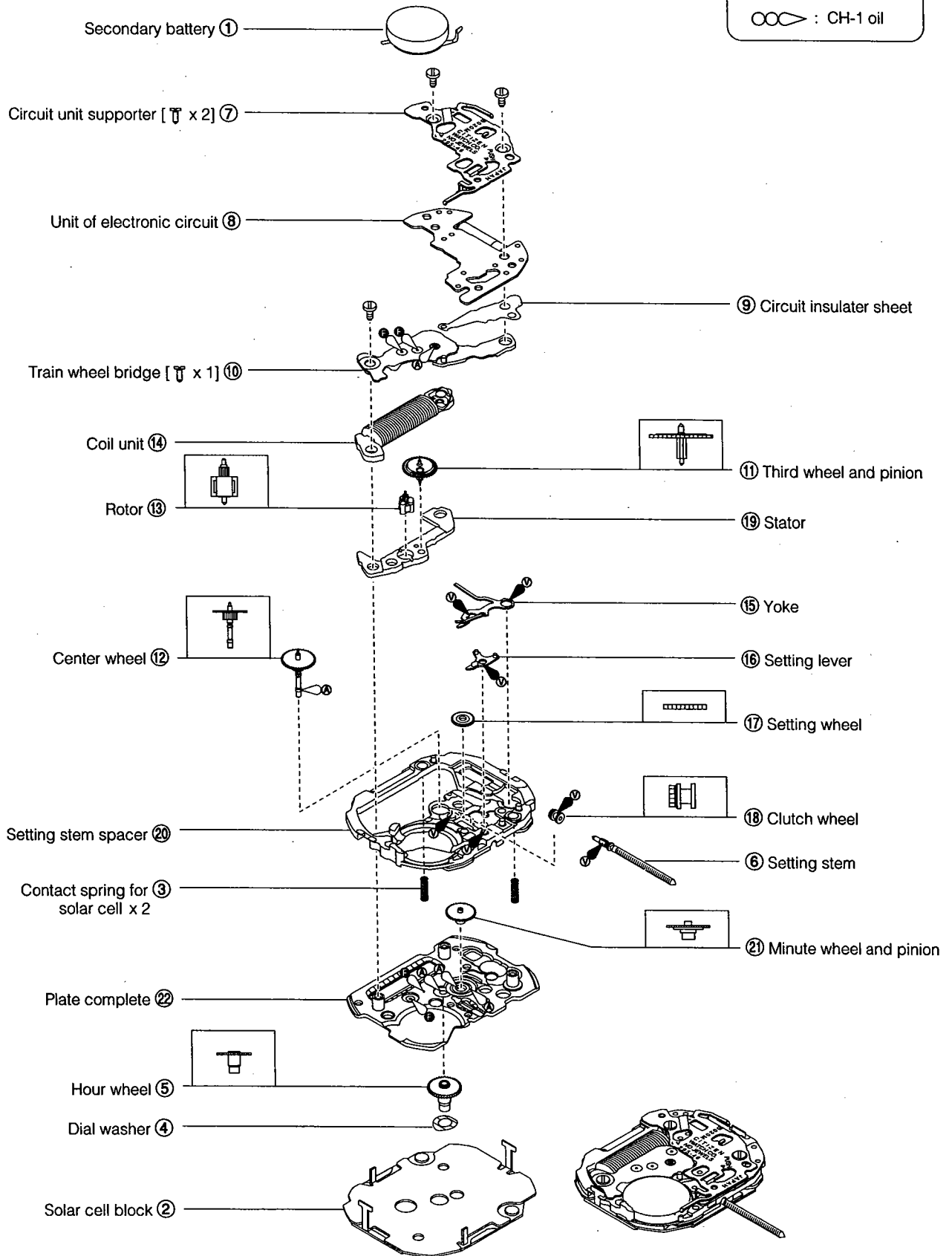

§8. DISASSEMBLY AND ASSEMBLY OF MOVEMENT (Cal. B030)

Disassembly procedure: ① → ②⑤
 Assembly procedure: ②⑤ → ①

● Lubrication mark

- Ⓐ : A-Lube oil
- Ⓥ : V-Lube oil
- ⓕ : F-Lube oil
- ⓄⓄ : CH-1 oil

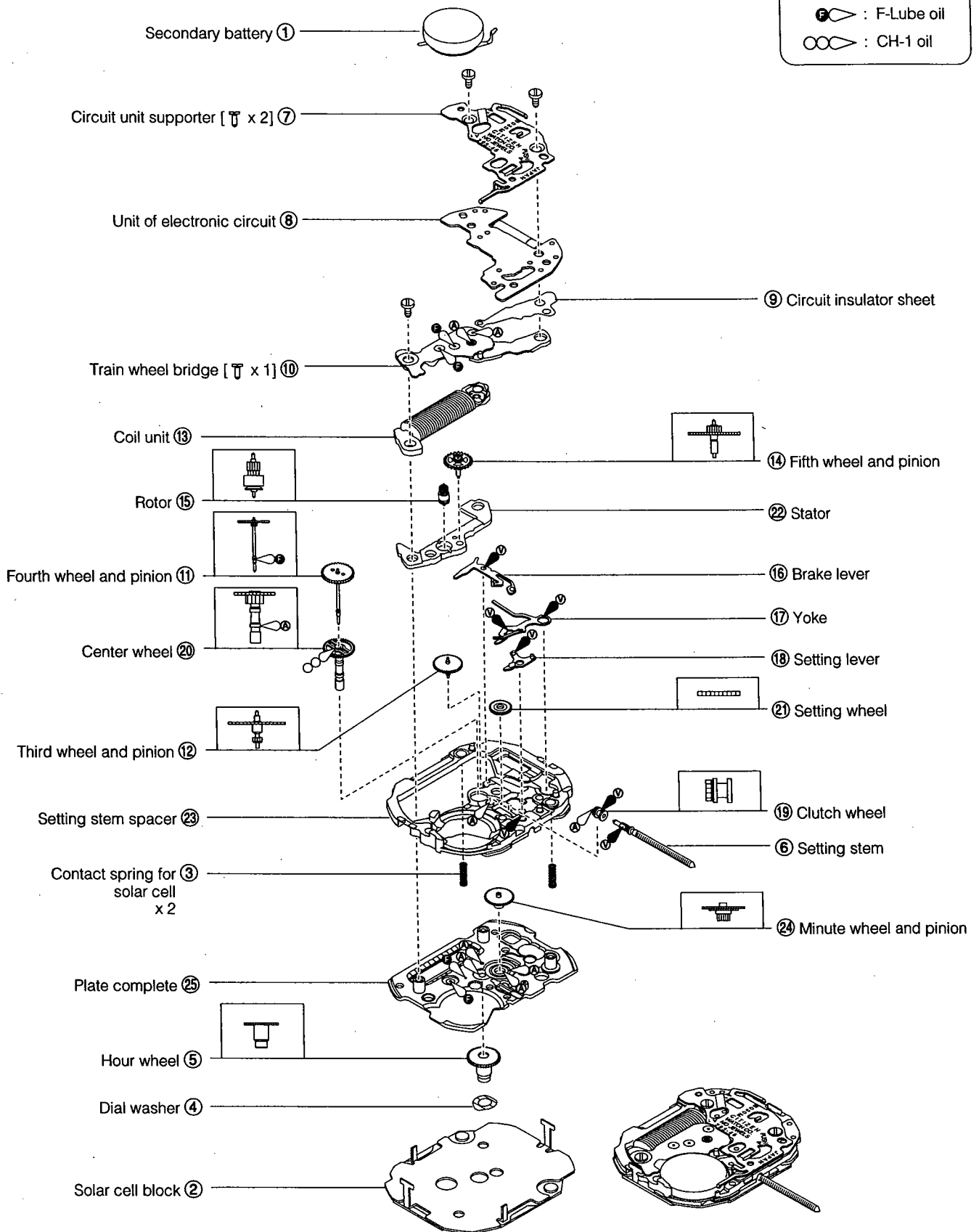

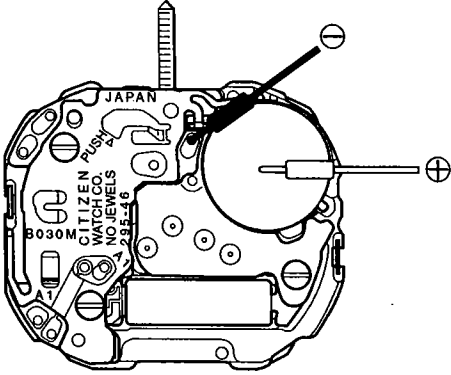
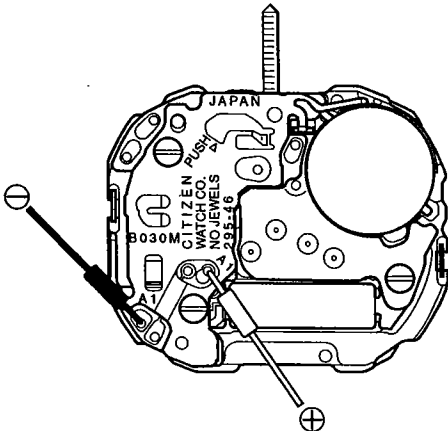
Check Items	How to Check	Results and Treatments
<p>① Measurement of secondary battery voltage</p>	<p style="text-align: right;"><Tester range: DC. 3V></p>  <p>Reference:</p> <ul style="list-style-type: none"> • 0.9V ~ 1.3V: Insufficient charge warning display (One-minute or Two-second interval movement mode) • 1.3V ~ 2.6V: Normal movement mode <p>These voltages may vary slightly from watch to watch.</p> <ul style="list-style-type: none"> • Time setting warning display is a function that signals that the watch has topped and restarted. This mode will continue until the watch is set to the correct time, irrespective of the voltage. <div style="border: 1px solid black; padding: 5px; margin-top: 10px;"> <p>Note: When measuring the voltage, be careful not to place the ⊖ tester pin on the secondary battery strap (a short circuit will occur.)</p> </div>	
<p>② Confirmation of output signal</p>	<p>* Refer to Technical Manual, Basic Course: II-1-b.</p> <p style="text-align: right;"><Tester range: DC. 0.3V></p> <p><The tester lead pins have no polarity.></p>  <ul style="list-style-type: none"> • In the normal movement mode, the tester pointer should moves to the right and left every 20 seconds (or 1 second) • In the insufficient charge warning display or time setting warning display mode, the test pointer moves in only one direction 1 minute (or 2 seconds) 	<ul style="list-style-type: none"> • Tester pointer swings. → Normal. • Tester pointer does not swing. → Check connections. <p style="text-align: center;">↓</p> <ul style="list-style-type: none"> • Connections are normal. → Replace the electronic circuit.

Check Items	How to Check	Results and Treatments
③ Check of connection parts	<ul style="list-style-type: none"> * Refer to Technical Manual, Basic Course: II-2-a. • Check for looseness of screws, dust, stain, etc. • Check for stain and removal of the solar cell pattern (two places), deformation of connection spring, removal of welded lead plate of the secondary battery, stain of the circuit pattern, bad contact of each part. 	<p>Stain of solar cell pattern and circuit pattern. → Remove stain.</p> <p>Removal of solar cell pattern, removal of circuit pattern, removal of welded lead plate of secondary battery. → Replace parts.</p>
④ Measurement of coil resistance	<ul style="list-style-type: none"> * Refer to Technical Manual, Basic Course: II-1-c. • Remove the unit of electronic circuit and measure the coil resistance <p style="text-align: right;"><Tester range: R x 10Ω></p> <p><The tester lead pins have no polarity></p>	<p>For Cal. B020</p> <ul style="list-style-type: none"> • 2.3 kΩ - 2.7 kΩ → Normal <p>For Cal. B030</p> <ul style="list-style-type: none"> • 1.5 kΩ - 1.9 kΩ → Normal • Out of above range → Replace coil unit
⑤ Check of train wheel	<ul style="list-style-type: none"> * Refer to Basic Course: II-2-b. 	
⑥ Check of dial side mechanism	<ul style="list-style-type: none"> * Refer to Basic Course: II-2-c. 	
⑦ Check of solar cell	<ul style="list-style-type: none"> • Check the solar cell for breakage and stain, and check its electrode for stain and flaking. 	<ul style="list-style-type: none"> • Breakage of solar cell → Replace solar cell. • Stain → Remove stain. • Flaking of electrode → Replace solar cell.
⑧ Measurement of time rate	<ul style="list-style-type: none"> * Refer to Basic Course: II-2-d. <p style="text-align: right;"><Measurement gate: Analog 10 sec></p> <ul style="list-style-type: none"> • The time rate cannot be adjusted. • The time rate may not be measured accurately while the insufficient charge warning display or time setting warning display is turned on. In this case, apply light to the watch until the hand moves normally, then measure the time rate. 	<ul style="list-style-type: none"> • The watch loses or gains substantial time → Replace the unit of electronic circuit

Check Items	How to Check	Results and Treatments
<p>9 Confirmation of using condition</p>	<p>* Refer to Basic Course: II-2-e.</p> <ul style="list-style-type: none"> • Since this watch is energized by light, it should receive light as much as possible. If the watch is placed near a light source which generates heat (above 60°C) such as an incandescent lamp, a halogen lamp, etc., its functions and parts may be deteriorated or deformed by the heat. Accordingly, take care when applying light to it. <p>Example: When the watch is hidden under a long sleeve or the customer works in a dark place, it needs to be exposed to light on purpose.</p> <ul style="list-style-type: none"> • It is important to check that the secondary battery is charged normally (the customer knows that this watch is a solar watch) and explain the correct charging method to the customer. 	
<p>10 Measurement of current consumption (Cal. B020)</p>	<p>* Refer to Technical Manual, Basic Course: II-1-f.</p> <p>This watch uses the secondary battery block, instead of an ordinary battery. Accordingly, prepare a silver battery (1.55V) and measure the current consumption according to the following procedure.</p> <ol style="list-style-type: none"> (1) Remove the second battery. (2) Referring to Technical Manual, Basic Course, set the silver battery (1.55V) to the adapter of the tester correctly. (3) Pull out the crown. (4) Set the tester. Keep the tester lead pins applied until the measurement of the current consumption is completed. (5) Return the crown to the normal position. (6) Short terminal A of the electronic circuit unit to the circuit unit supporter ⊕ for 1 second or more to set the watch in the one-second interval movement mode. (7) Measure the current consumed by the movement. <div data-bbox="521 1310 1000 1724" data-label="Diagram"> </div> <p style="text-align: center;"><Tester range: DC 10μA></p> <div data-bbox="488 1808 1118 1982" data-label="Text" style="border: 1px solid black; padding: 5px;"> <p>Note: When measuring the current consumption, do not apply any light to the solar cell. If any light is applied, the voltage changes and correct current consumption cannot be measured.</p> </div>	<ul style="list-style-type: none"> • Current consumption of movement Under 1.8μA → Normal • Over 1.8μA → Check train wheel and dial-side mechanism. → Remove dust and dirt. <p style="text-align: center;">↓</p> <ul style="list-style-type: none"> • Current consumption measured again. Over 1.8μA → Replace the unit of electronic circuit.

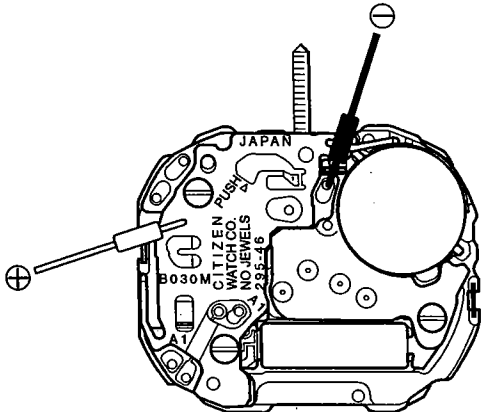
Check Items	How to Check	Results and Treatments
<p>⑪ Measurement of current consumption (Cal. B030)</p>	<p>* Refer to Technical Manual, Basic Course: II-1-f.</p> <ul style="list-style-type: none"> This watch uses the secondary battery block, instead of a ordinary battery. Accordingly, prepare a silver battery (1.55V) and measure the current consumption according to the following procedure. <ol style="list-style-type: none"> Remove the secondary battery. Referring to Technical Manual, Basic Course, set the silver battery (1.55V) to the adapter of the tester correctly. Pull out the crown. Set the tester.  <p style="text-align: center;"><Tester range: DC 10μA></p> <ol style="list-style-type: none"> Return the crown to the normal position and measure the current consumption of the movement. <div style="border: 1px solid black; padding: 5px; margin-top: 10px;"> <p>Note: When measuring the current consumption, do not apply any light to the solar cell. If any light is applied, the voltage changes and correct current consumption cannot be measured.</p> </div>	<ul style="list-style-type: none"> Current consumption of the movement Under 0.8μA → Normal Over 0.8μA → Check train wheel and dial-side mechanism. → Remove dust and dirt. <p style="text-align: center;">↓</p> <ul style="list-style-type: none"> Current consumption measured again Over 0.8μA → Replace the unit of electronic circuit.
<p>⑫ Check of appearance and function</p>	<p>* Refer to Basic Course: II-2-f.</p>	